

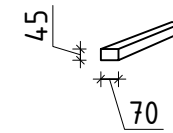

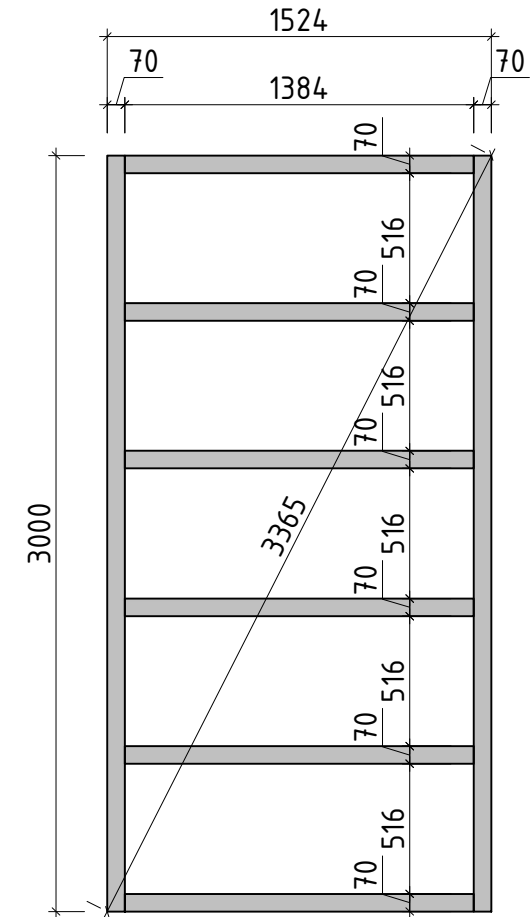

Name	Anbauschuppen B 160x320 40		
Profil	4x11.4	Zeichnung	3D
Datum	17.06.2022		

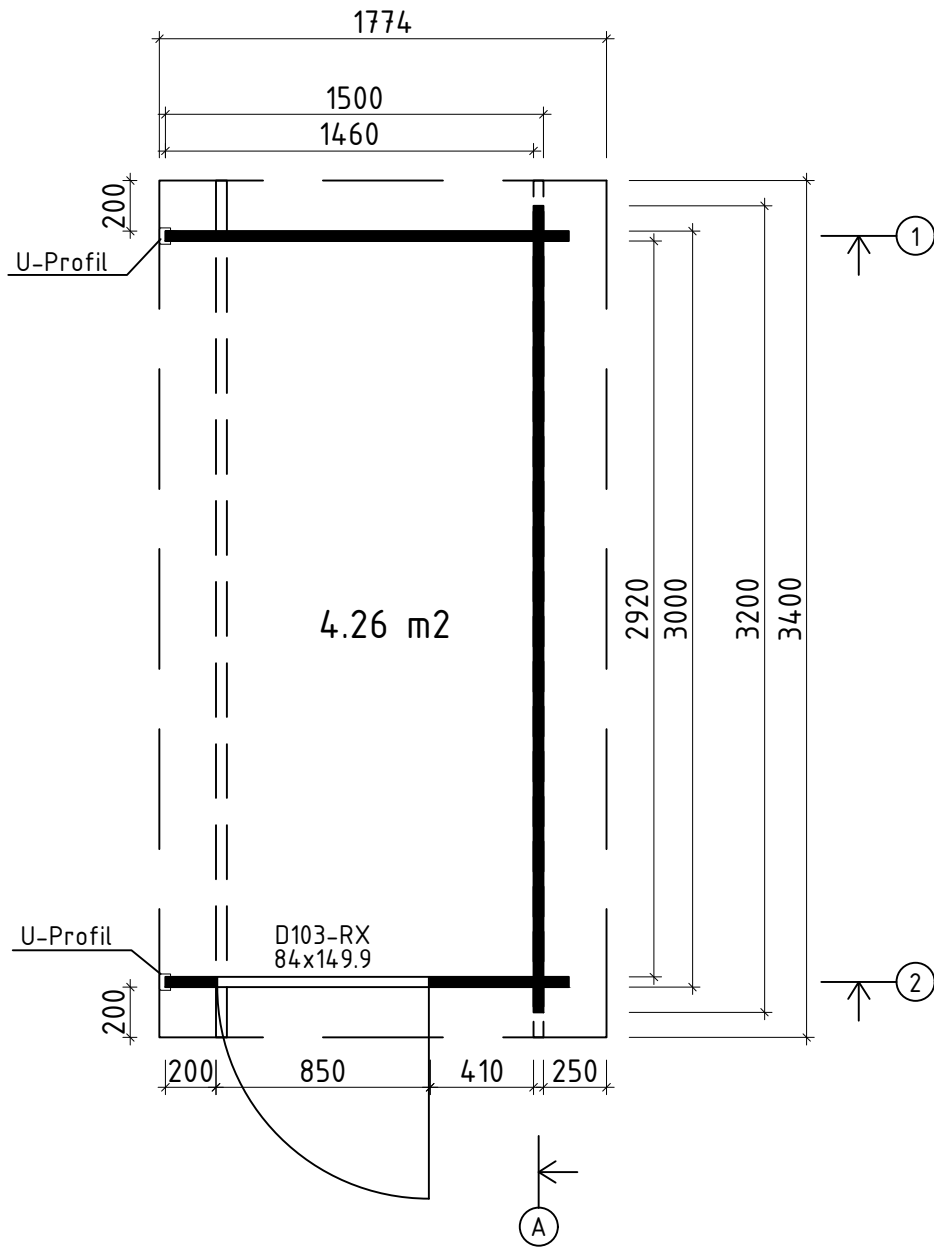
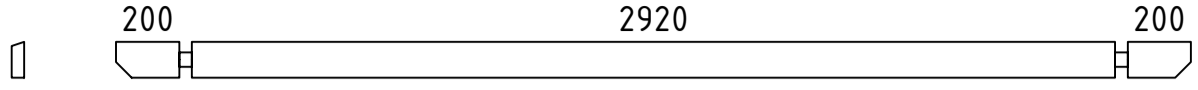
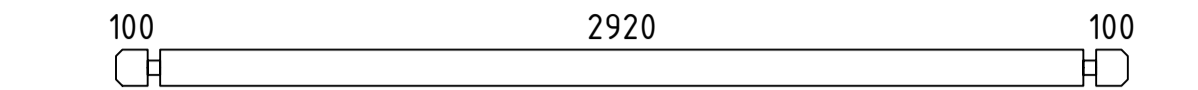
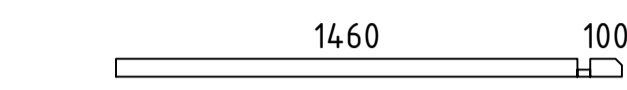
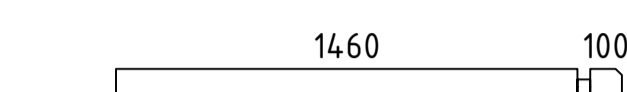
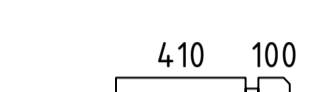
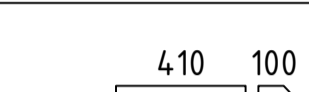

Q2 – Qualitätsklasse für Fenster und Türen

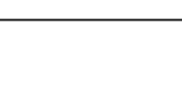
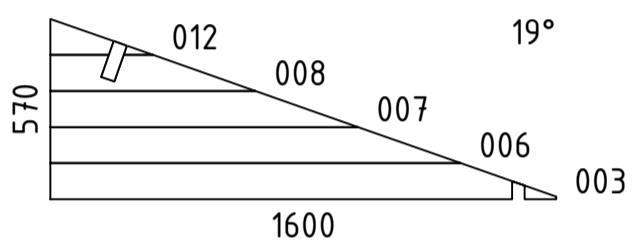
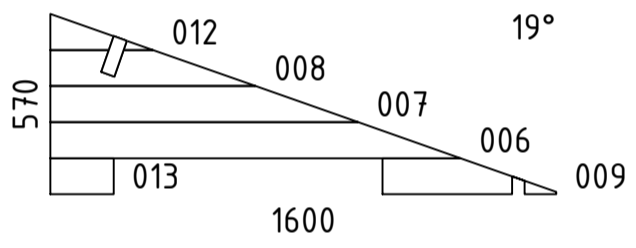
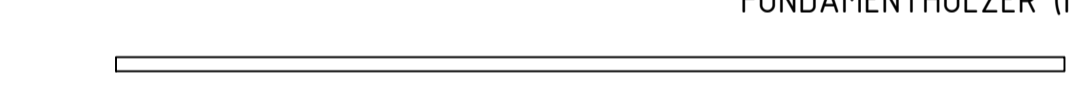
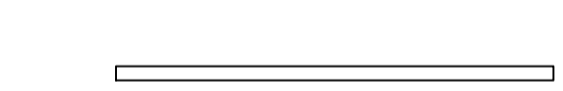
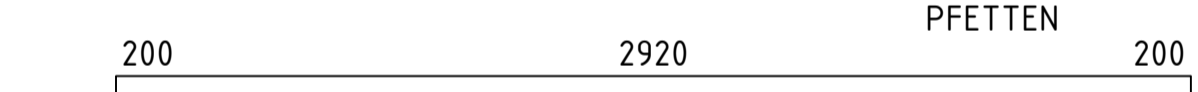
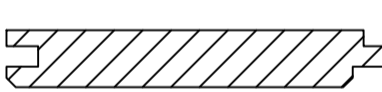
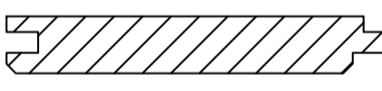
Name	Anbauschiippen B 160x320 40		
Profil	4x11.4	Zeichnung	Grundplan , Lagerholzplan
		Datum	17.06.2022

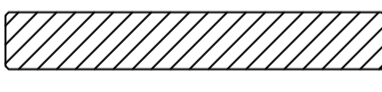
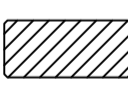
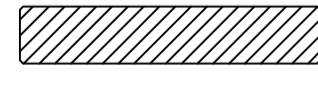
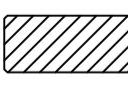
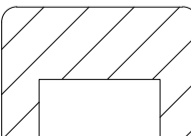
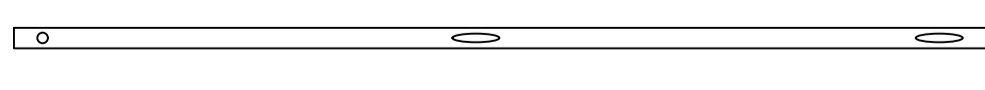
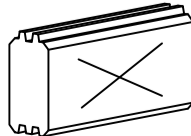
Pos	Teilleiste Anbauschuppen B 160x320 40		Stck.	Profil (mm)	Länge (mm)
001			1	40x114	3400
002			12	40x114	3200
004			1	40x57	1600
005			12	40x114	1600
010			12	40x114	550
011			1	40x57	550
013			12	40x114	200
014			1	40x57	200
W1-1			1		
W2-1			1		
FH1	FUNDAMENTHÖLZER (imprägniert) 		2	70x45	3000
FH2	FUNDAMENTHÖLZER (imprägniert) 		6	70x45	1384
PF1	PFETTEN 		1	44x145	3400
	DACHBRETTER		31+1	113x18	1880
	FUSSBODENBRETTER		14+1	113x18	2915
	FUSSBODENLEISTEN			18x40	10.0lfm
G02-1	GIEBELBRETTER 18x120		2	18x120	1920
G05-1	GIEBELDECKLEISTEN 18x40		2	18x40	1920
T01-1	TRAUFBRETTER 18x95		1	18x95	3400
T06-1	TRAUFBRETTER 18x40		2	18x40	7.0lfm
UP2-1	U-PROFIL 40		2	44x65	1995
SM-1	Sturmleisten		2	18x40	1370
SH	Schlaghölzer		3		
Kood	Anbauschuppen B 160x320 40	Material	File	Leht	1/3

Pos	Teilleiste Anbauschuppen B 160x320 40		Stck.	Profil (mm)	Länge (mm)
NG04	NÄGEL 2.5x50	Dachbretter Fussbodenbretter	292		
SR32	SCHRAUBEN 3.0x30	Fussbodenleisten Traufenleiste 18x40	35		
SR37	SCHRAUBEN 3.5x45	Giebelbretter, Traufenbretter Giebeldeckleiste 18x40, U-Profil	35		
SR57	SCHRAUBEN 5.0x100	Fundamenthölzer	32		
SS024	Schloßschrauben M8x70 Mutter M8 U-Scheibe Ø25 - Befestigung für Sturmleisten		6		

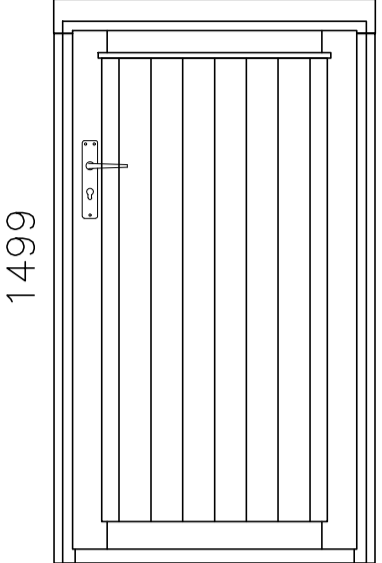
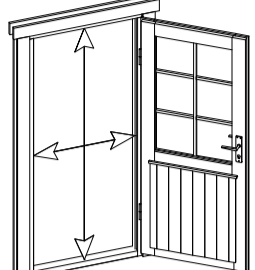
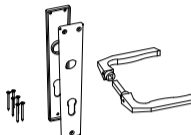
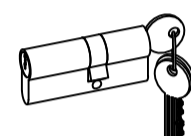
Pos	Teileliste Anbauschuppen B 160x320 40	Stck.	Profil (mm)	Länge (mm)
	<p>TÜR 840x1499 D2-S40R-XXX-08401499</p> <p>Q2 D103-RX 840</p>  <p>1499</p> <div style="border: 1px solid black; border-radius: 10px; padding: 5px; width: fit-content;"> Right handed / DIN rechts / paremakäeline </div> <div style="border: 1px solid black; border-radius: 10px; padding: 5px; width: fit-content; margin-top: 5px;"> Clear opening/ durchgangsmaß/ ava suurus 752x1411mm </div> 	1		
UL-Q 2-Q3	Q2-Q3 Door handle - Türgriff - Ukselink		1	
LS-Q4	Q4 Cylinder lock - Zylinderschloss - Lukusüdamik		1	
	✓ - bitte selber anpassen (falls nötig)!			
Kood	Anbauschuppen B 160x320 40	Material	File	Leht 3/3

Uks	Q2-Q3	-	koostamisjuhhis
Door	Q2-Q3	-	assembly instructions
Tür	Q2-Q3	-	Montageanleitung

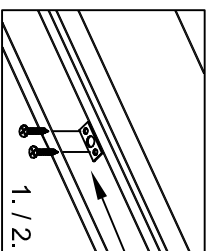
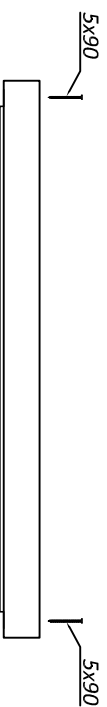
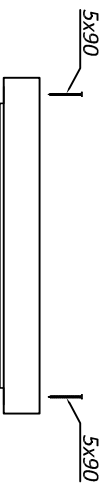

Ø8-10

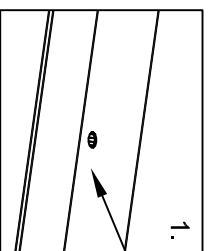
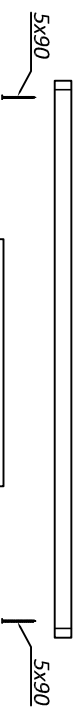
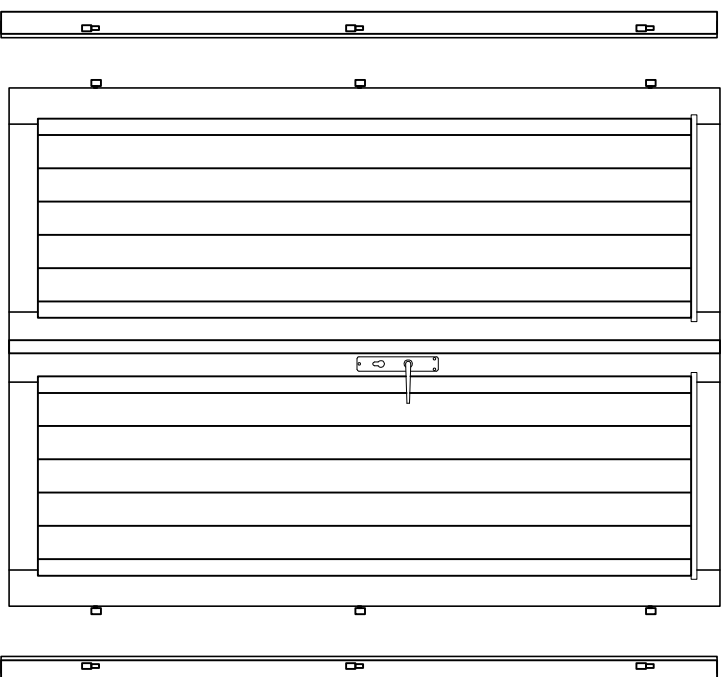
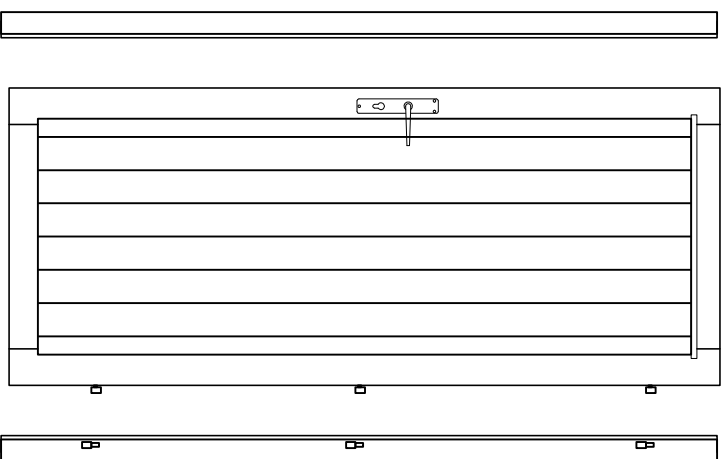

Ø8-10

*Kui ühepoolne uks ei ole kokku pandud!
 *When single door is not assembled!
 *Wenn Einzeltür ist nicht zusammengebaut!

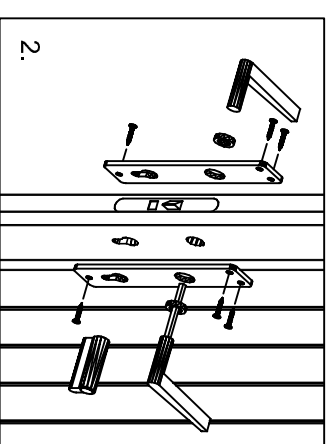
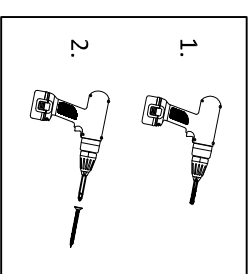

*Kui hinged ei ole paigaldatud!
 *When hinges are not attached!
 *Wenn Scharniere sind nicht angebracht!

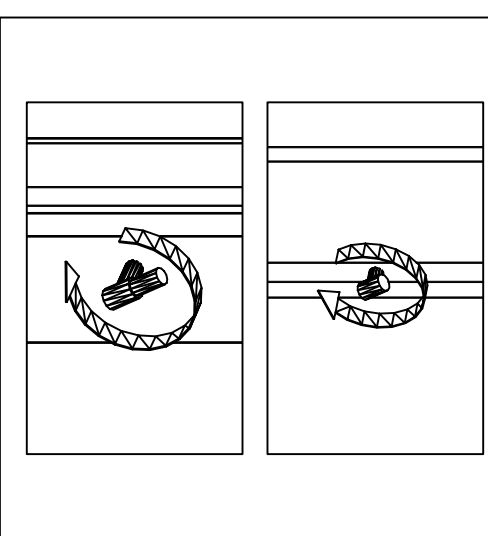

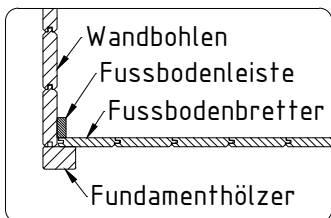
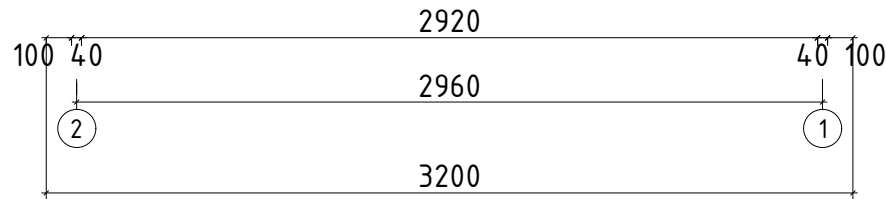
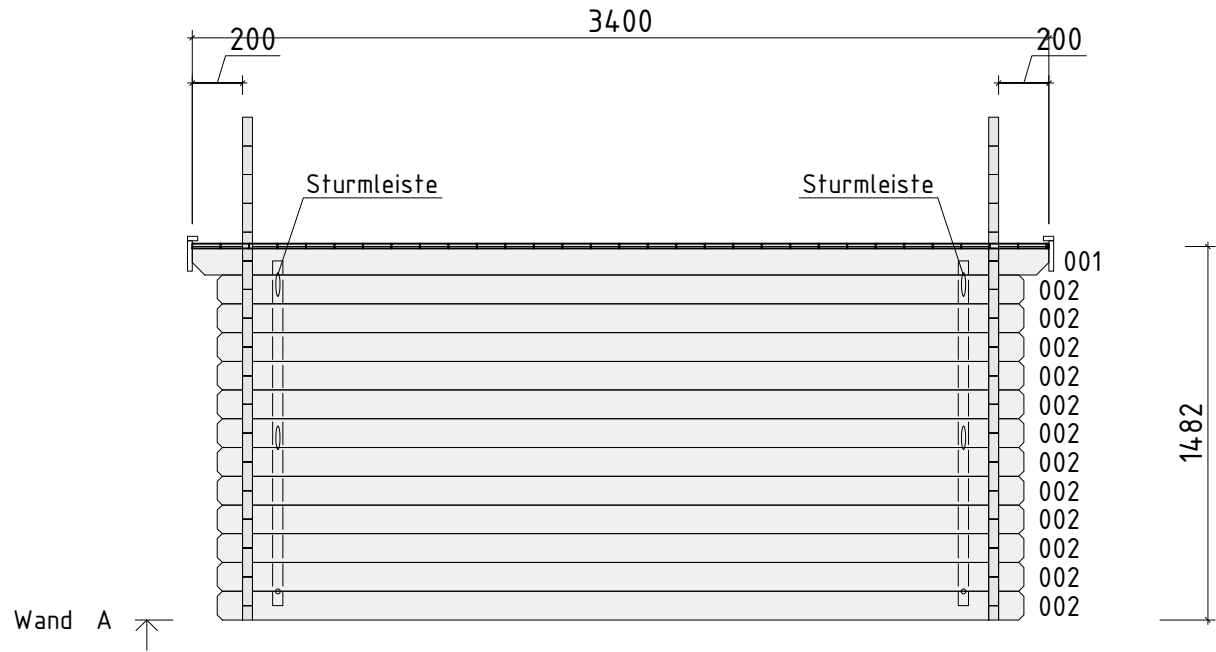
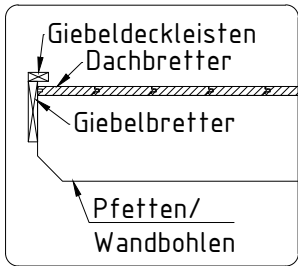

Name	Anbauschuppen B 160x320 40		
Profil	4.0x11.4	Zeichnung	WAND A
		Datum	17.06.2022

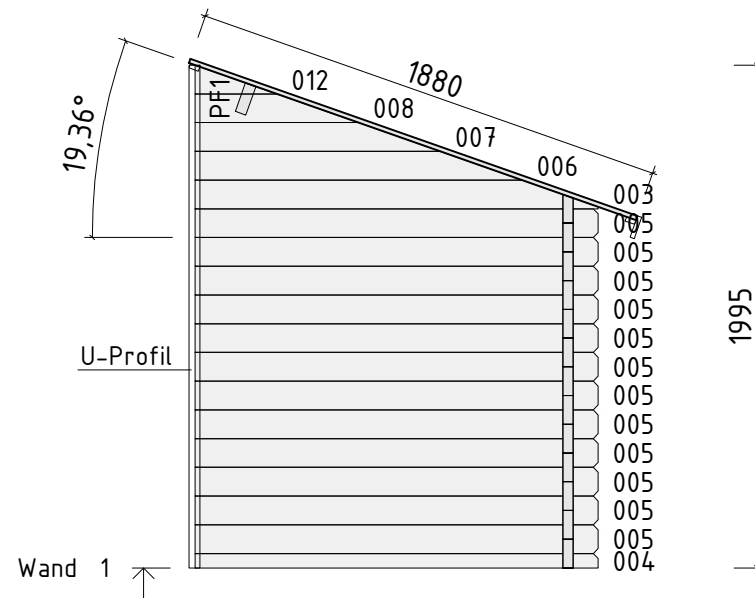
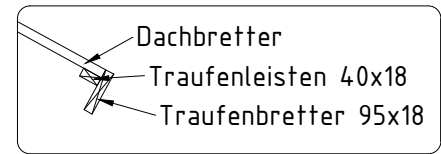

1995

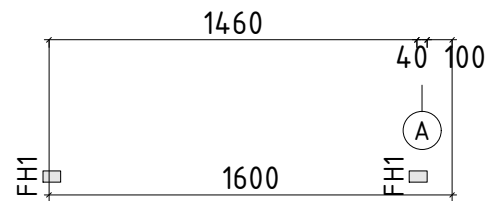

Name	Anbauschruppen B 160x320 40		
Profil	4.0x11.4	Zeichnung	WAND 1
		Datum	17.06.2022

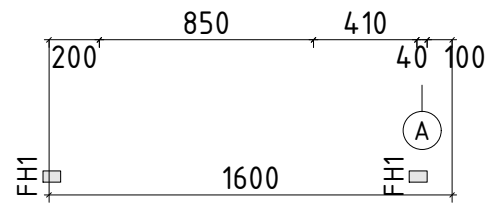
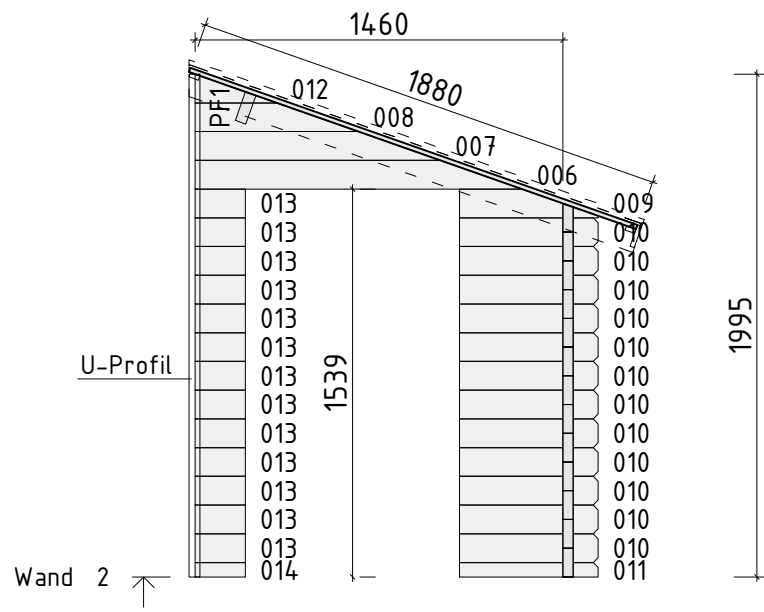

Name		Anbauschuppen B 160x320 40	
Profil	4.0x11.4	Zeichnung	WAND 2
		Datum	17.06.2022